

Starting Steps, Treads, Risers, Mouldings & Tread Covers



Single end starting steps are either right or left hand. Please specify. Add 10% for reversible.

Starting steps made to order. Please check lead time.



NOTE: Add to all starting steps - \$50.00 for each 12" over the 48" shown. Radius end cove and/or shoe optional at \$50.00 per each cove or shoe (includes straight piece).

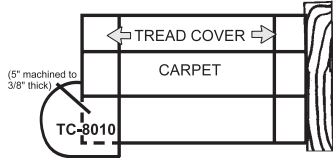

TC-8010-5" \$150.00
Designed for use on stairs with volutes or turnouts, using tread covers. 5" machined to 3/8" thick. Radius end cove included.

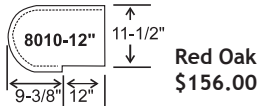

Red Oak \$156.00

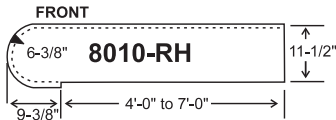

Red Oak 48" \$215.00

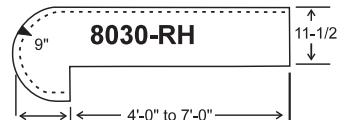

Red Oak 48" \$290.00

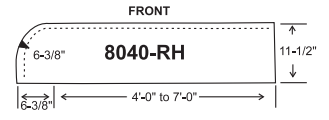

Red Oak 48" \$245.00

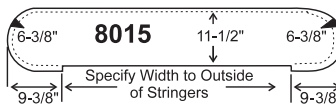

Red Oak 48" \$310.00

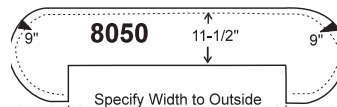

Red Oak 48" \$375.00

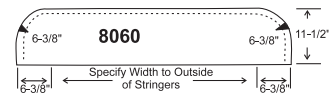

Red Oak 48" \$300.00

NOSING



1-1/16" x 1-1/4"
8080-RO \$2.50
8080-A \$2.60
HN - \$1.30 (Hemlock)

COVE



3/4" x 3/4"
8095-RO \$1.35
8095-A \$3.00

PENCIL MOULDING



3/4"

MXPM-KA \$3.20

PANEL CAP

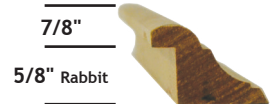

7/8"

5/8" Rabbit

1"

MXPC-KA \$5.00

LANDING TREAD



1-1/16" X 3-1/2"
8090-RO \$5.83
HLT 3.50 (Hemlock)

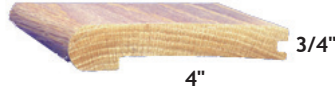

1-1/16" x 5-1/4"
8090-5 RO \$8.60
8090-5 A 8.60

TREADS & RISERS

Custom Sizes & Species Available on Quote.



1-1/16" x 11-1/2"
8070 PLAIN TREAD

3/4" x 7-1/4"
8075-RO RISER

| | Red Oak | Hemlock | Red Oak |
|-----|----------|----------|---------|
| 36" | \$ 41.70 | \$ 26.25 | \$21.67 |
| 42" | 49.58 | 30.42 | 25.90 |
| 48" | 56.67 | 35.00 | 32.92 |
| 60" | 73.33 | 43.33 | 42.92 |
| 72" | 88.33 | -- | 51.25 |
| 96" | 148.50 | -- | |

TREAD COVERS

Solid Panel 3/8" Thick; Nosing 1" x 1-3/8"; Cove 3/4" x 3/4".

Can be job cut right or left hand (left shown).

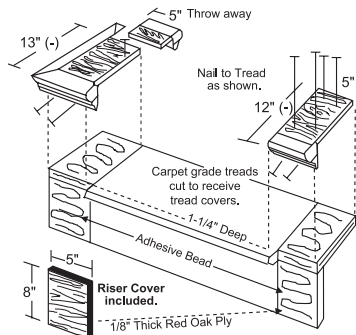

Tread Cover Wall End
Code TRC-WE
Red Oak \$14.50
Maple 19.00
Alder 22.00
Cherry 26.00

Tread Cover Open End
Miter Return
Code TRC-OE
Red Oak \$22.08
Maple 29.00
Alder 30.00
Cherry 34.00

Riser Cover Also Sold Separately \$5.00

(Cove Moulding unattached)

Hemlock Treads are Finger Jointed

MITERED RETURN TREAD
ADD \$40.00
TO PLAIN TREADS

